Testing CDMA Base Station Amplifiers

Application Note 1307

Measurement fundamentals of characterizing the linear and non-linear behavior of CDMA power amplifiers



Table of contents

Introduction	.4
1. Overview	.5
1.1 Amplifier measurements	.5
1.2 Power amplifier characteristics	.6
1.3 Common CDMA base-station amplifier requirements	.7
2. Test-system requirements	.8
2.1 Stimulus response measurements	.8
2.2 Network analyzer requirements	.8
2.3 High-power considerations	.9
2.4 Typical test setups	.10
2.5 Digital signal generator requirements	.13
2.6 Signal analyzer requirements	.14
2.7 Power meter requirements	.14
3. Measurements and test instruments	.15
3.1 Pulsed RF and pulsed bias	.15
3.2 Load-pull analysis	.17
3.3 Network analysis	.18
3.3.1 Transmission measurements	.18
3.3.1.1 Gain and flatness	.19
3.3.1.2 Phase	.20
3.3.1.3 Group delay	.21
3.3.1.4 Reverse isolation	.22
3.3.2 Reflection measurements	.23
3.3.2.1 Return loss/SWR	.24
3.3.2.2 Input impedance	.25
3.3.2.3 Output impedance	.25
3.4 In-channel measurements	.26
3.4.1 RF channel output power	.26
3.4.2 Occupied bandwidth	.28
3.5 Out-of-channel measurements	.29
3.5.1 Harmonic distortion	.29
3.5.2 Adjacent channel power ratio	.30
3.5.3 Spectral regrowth	.32
4. Summary	.34
5. References	.36

Introduction

This application note covers the testing needs and issues encountered in the development of CDMA high-power base station amplifiers.

The amplifier provides a fundamental function of the base station in a wireless communications system. The signal level must be amplified enough to overcome the inherent losses during wireless transmission so that it can be received by the mobiles. The design requirements for RF power amplifiers include high output power, high linearity, and good efficiency.

CDMA systems are experiencing tremendous growth in the global communication marketplace. This growth is fueling many research programs and expanding the technology opportunities for all manufacturers. Coupled with this large growth are some challenging measurement problems.

The objective of this application note is to cover the basic measurement fundamentals of characterizing the linear and non-linear behavior of CDMA power amplifiers. In addition, it features some of the latest test solutions developed by Hewlett-Packard for design validation, and for manufacturing test of CDMA base station amplifiers.

The overview begins by presenting power amplifier measurements, defining the characteristics of power amplifiers, and presenting specific CDMA amplifier requirements. Next, the different test system architectures that can be used for testing power amplifiers are analyzed and the limitations of each are discussed. A brief look at the requirements for the individual pieces of test equipment will be presented as well.

The section titled 'Measurements and test instruments' briefly covers amplifier testing under pulsed-RF and pulsed-bias conditions. This is often necessary for testing unpackaged devices that lack sufficient heatsinking to be run continuously. Also, briefly explored is how load-pull analysis can be used to optimize the design of a power amplifier. In this same section, the more common measurements are covered in more detail, starting with vector network analyzer-based transmission and reflection measurements, which include both linear and non-linear tests. Additional non-linear measurements such as in- and out-of-channel measurements which require a different set of test equipment, are presented at the end of the section.

1. Overview

1.1 Amplifier measurements

Figure 1: Common amplifier measurements

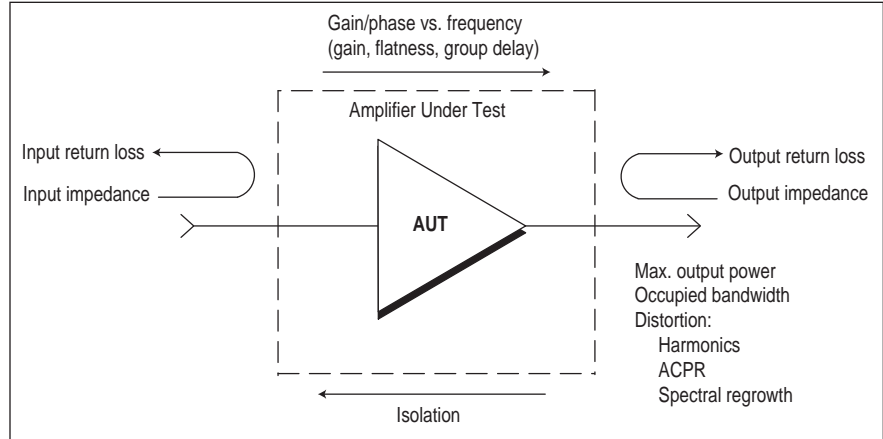

Power amplifiers are active, two-port devices which exhibit both linear and non-linear behavior. This illustration highlights some of the measurement parameters used to specify power amplifier performance.

Common transmission parameters from a vector network analyzer include gain, gain flatness, isolation, phase and group delay. Note that for CDMA, gain compression is typically not performed. This is due to the high peak-to-average ratios experienced in CDMA.

Common reflection parameters of interest for the power amplifier are Voltage Standing Wave Ratio (VSWR), return loss, and input and output impedance, which are important for maximum power transfer through the amplifier.

Several measurements need a more complex stimulus than a simple CW frequency. For example, a CDMA signal is needed for accurately characterizing output channel power, occupied bandwidth and distortion performance of the amplifier.

Distortion measurements are very important for characterizing the amplifier's linearity. The growth of digital communications systems has increased the demand for highly efficient, linear amplifiers. Non-linearities in amplifier gain causes adjacent channel interference and reduced spectral efficiency. Testing for distortion helps ensure proper in-band and out-of-band operation.

1.2 Power Amplifier Characteristics

Figure 2: Characteristics of a high-power amplifier

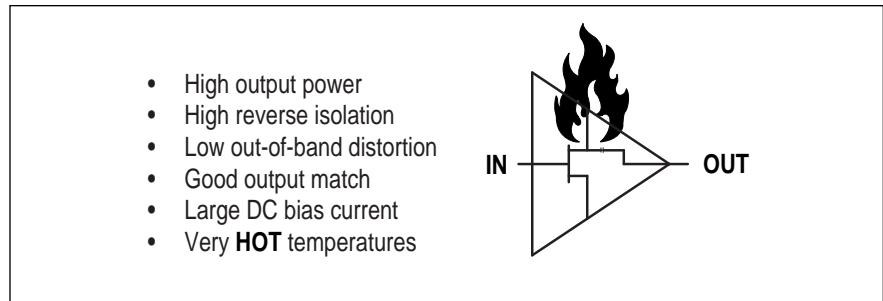

Amplifier designers have to make difficult choices when optimizing a design for a specific power amplifier. In certain cases, designers select output power as the key power-amplifier parameter to optimize. However, every good designer knows that to optimize only one parameter of a design means that other parameters are compromised. For this reason design engineers must consider all the significant variables, such as gain, distortion, efficiency, size, and cost.

Nevertheless, power amplifiers can still be recognized by some key characteristics. They are most commonly recognized by their high output power which can be as low as 1 W and as high as hundreds of watts.

In addition, power amplifiers usually have good reverse isolation that helps to protect the system components, located before the amplifier, from large reflections throughout the system.

Power amplifiers are also designed to have good out-of-band distortion. This ensures minimal or negligible interference in the adjacent channels.

Since the main purpose of the power amplifier is to deliver power into the antenna as efficiently as possible, it is imperative that the output impedance of a power amplifier preserve the maximum power transfer through the amplifier.

CDMA power amplifiers, which operate in the linear region, are not very efficient, so they require a large amount of DC power to generate a lesser amount of RF power. Only a portion of the DC current is used to generate the RF power; a much larger portion turns into heat. This is why power amplifiers operate at such high temperatures, and therefore require large heat-sinks, or external cooling systems.

1.3 Common CDMA base station amplifier requirements

Figure 3: Typical requirements for CDMA base station amplifiers

Frequency ranges	824 - 894 MHz, 1810 - 1870 MHz, 1930 - 1990 MHz, and so forth.
Output power	8 - 45 W
Gain	30 - 40 dB
Gain flatness	± 0.5 dB
Input match	1.2 to 1
Adjacent channel power ratio (ACPR)	vendor specific but typically better than system specs: < 45 dBc @ ± 885 kHz offset, < 60 dBc @ ± 1.98 kHz and ± 2.25 kHz offsets
Group delay	4 ns ± 2 ns

Figure 3 is a table summarizing the key requirements for a CDMA base station amplifier such as frequency range, maximum transmit power, and gain. These specifications are typically set by the base station manufacturer, and can differ from manufacturer to manufacturer depending upon their system design.

New applications are placing more stringent demands on current designs requiring amplifiers to have attributes such as smaller size, higher gain, better gain flatness, less distortion, and higher output power. Developments such as multi-carrier power amplifiers (MCPAs) place additional demands on CDMA amplifier designs.

These specifications illustrate the tighter tolerances being placed on common parameters, as well as new specifications being required such as group delay and adjacent-channel-power ratio. These requirements place new demands on the test instrumentation for full characterization.

2. Test system requirements

2.1 Stimulus response measurements

Figure 4: Test instruments for making stimulus response measurements

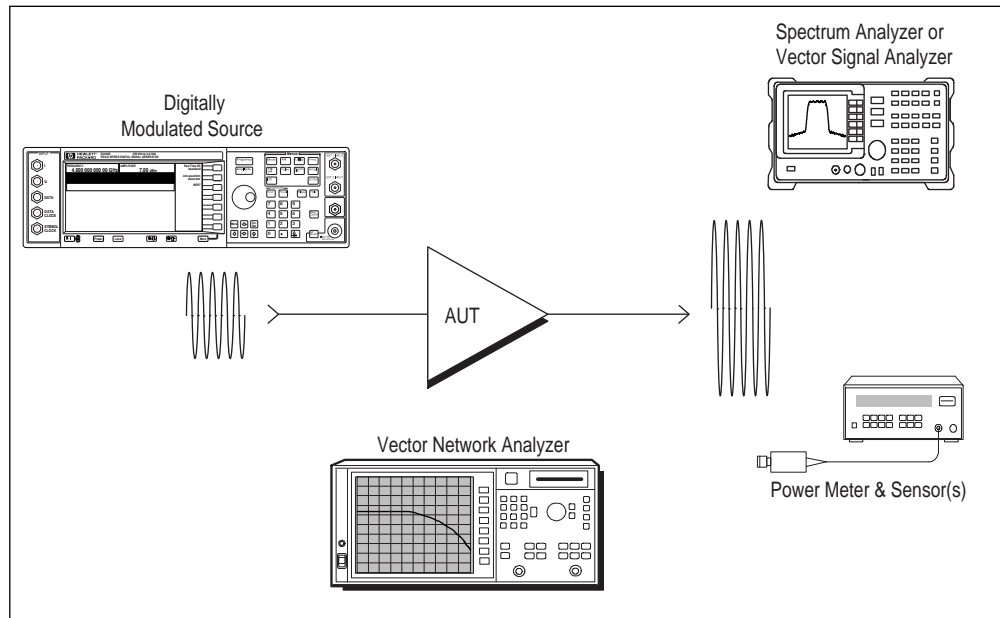

The complete characterization of the linear and non-linear behavior of amplifiers is achieved with stimulus response measurements.

Network-analysis measurements use a CW signal as the stimulus that is swept over frequency or power. A vector network analyzer is used to accomplish this task. In this case, both the source and receiver are in the same instrument.

Certain non-linear measurements require a separate source and receiver. The source must provide a more complex stimulus. For example, multitone or broadband-noise signals are used for some intermodulation-distortion measurements. Digitally-modulated signals are required for adjacent-channel-power and spectral-regrowth measurements. The receiver for this type of measurement is typically a spectrum analyzer or vector signal analyzer.

Power meters are an integral part of any test setup due to their exceptional accuracy in measuring output power.

2.2 Network analyzer requirements

When selecting a network analyzer, it is best to take into account the following guidelines:

- 1) It is necessary to have complete amplitude control of the RF source to deliver a wide range of output power, while still maintaining excellent power flatness versus frequency.
- 2) The raw (uncorrected) test port match must be good (return loss > 20 dB). This requirement is necessary to maintain high measurement accuracy and repeatability.

3) The system receiver must be capable of handling high output-power levels, while still maintaining excellent receiver linearity. These two requirements ensure that the receiver can safely handle the high power levels and still maintain accuracy for the low-level signals that occur during calibration.

Another important consideration for testing amplifiers with network analyzers is the detector type. There are two basic modes of detection for network analyzers: broadband and narrowband. The broadband mode uses diode detectors and does not provide phase information. The narrowband mode uses a tuned receiver and does provide phase information. It also provides more dynamic range, less noise, and reduced sensitivity to measurement errors caused by harmonic and other spurious signals.

When measuring CDMA base station amplifiers, narrowband mode should be used to achieve the most accurate and repeatable measurements.

2.3 High-power considerations

Testing high-power amplifiers is unique because the power levels required for testing are often beyond the measurement range of the test instruments.

Power amplifiers typically require high-input levels in order to characterize them under conditions similar to actual operation. Similarly, the output level is also large when tested close to actual operating conditions.

Ensuring an appropriate input level and not exceeding the compression and damage level of the test instruments are the two main concerns when testing high-power amplifiers:

To provide high-input power to the amplifier under test (AUT), it may be necessary to insert a booster amplifier in the input path. The booster amplifier should be selected with enough gain and output power to boost the input signal to the desired level. It should also be a very linear (Class A) amplifier, operating in its linear region, so as not to contribute any additional signal distortion.

To reduce the high output-power level from the AUT to a level that can be safely handled by the test equipment, it is required that an external high-power coupler or a high-power attenuator be installed at the output of the amplifier. Care should be taken when selecting this component to ensure that its power-handling capability is adequate.

To make accurate measurements, additional concerns or considerations include calibration and thermal issues:

The frequency-response effects of the attenuators and couplers must be considered since they are part of the test system. It is important to select components that provide the best raw match possible. Proper calibration techniques should be used to remove or minimize the effects of the external hardware in the system.

When calibrating the extra attenuation added after the amplifier, the input levels to the receiver may be low during the calibration cycle. The power levels must be significantly above the noise floor of the receiver for accurate measurements. Vector network analyzers are recommended for high-power applications since their noise floor is typically < -90 dBm, and they exhibit excellent receiver linearity over a wide range which also improves measurement accuracy.

Thermal considerations during the measurement should also be considered for accurate measurements. For example, when testing high-power amplifiers the load used on the output coupler must be able to absorb the power delivered by the amplifier under test. Most loads designed for small-signal use can only handle up to about one watt of power. Beyond that, special loads that can dissipate more power must be used. The temperature of the load should be allowed to stabilize if its impedance characteristics change significantly versus temperature. The amplifier itself may behave very differently at various temperatures, so the tests should be done when the amplifier is at the desired operating temperature.

2.4 Typical test setups

Choosing the appropriate test system configuration for making network analysis measurements depends upon the types of measurements that will be made and the desired accuracy.

Figure 5: Network analysis configuration for forward-direction measurements

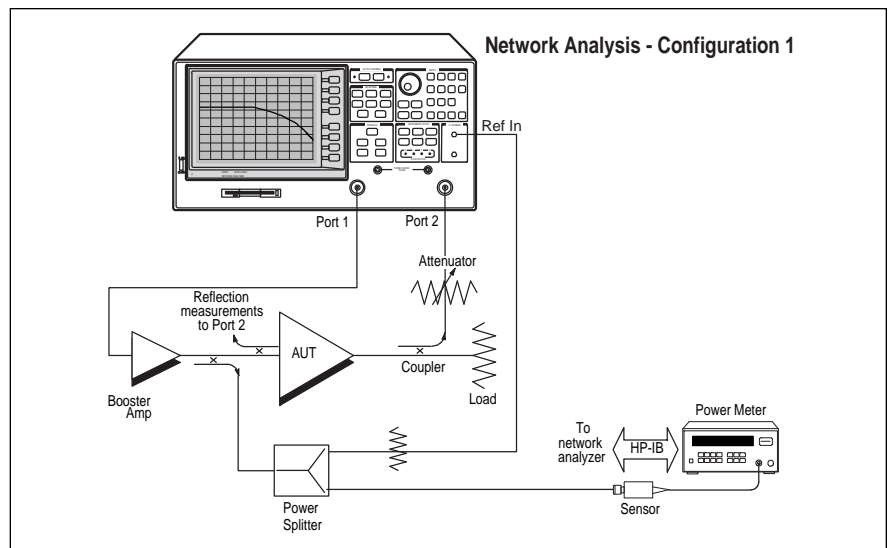

If both forward *and* reverse measurements are required, the configuration shown in Figure 6 can be used. This also provides higher accuracy since full two-port calibration can be performed.

In this configuration, the standard test set is modified so that high-power measurements can be made in both the forward and reverse directions. Modifications to the internal test set are typically options that the manufacturer can include with the analyzer.

Features that allow reverse direction and higher power levels to be measured include:

- 1) Access to the RF path between the source and the transfer switch. The source signal is amplified and then switched between Port 1 or Port 2. Forward and reverse high-power measurements can now be made.
- 2) Direct access to the 'R', or reference, channel as in the first configuration, allowing for improved accuracy.
- 3) Direct access to the RF path between the transfer switch and the test ports. This allows addition of high-power isolators to protect the transfer switch.
- 4) Step attenuators between the couplers and the samplers on the A and B channels. These reduce the signal to an optimum level for the receiver.

The HP 8720D family of vector network analyzers with Option 085 is ideal for making both reflection and transmission measurements in the forward and reverse directions without having to make multiple AUT connections. It is tailored for testing power amplifiers using Configuration 2, and covers the frequency range of 50 MHz to 13.5, 20, or 40 GHz.¹

Figure 7: Test configuration for in- and out-of-channel measurements

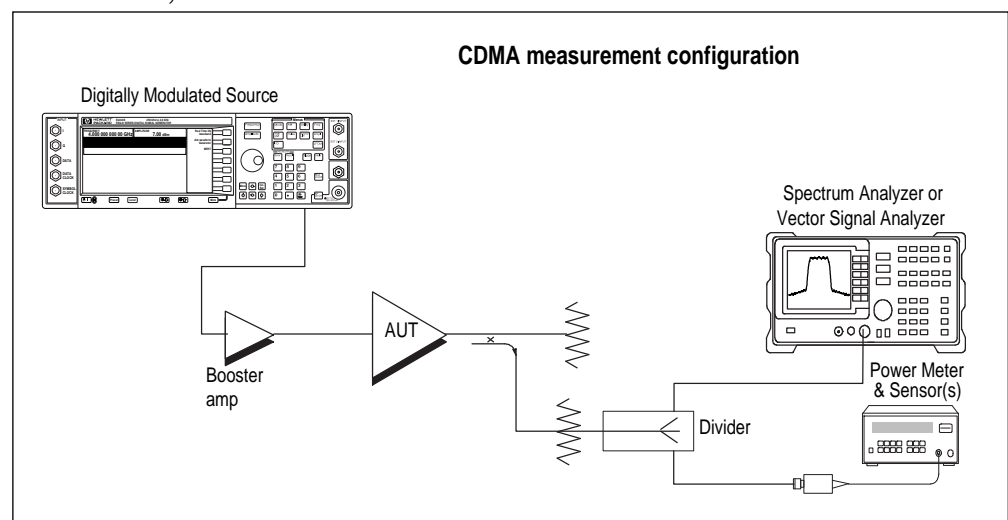

1. See reference 3 for more information on the other network analysis configurations.

When making CDMA measurements that require a separate source and receiver, the configuration shown in Figure 7 is used. In this case, some additional hardware is necessary.

A coupler in the input path (not shown) allows a CDMA signal to be injected into the system when needed. A divider in the output path allows analyzing the output signal on a variety of receivers such as a power meter, spectrum analyzer, or vector signal analyzer.

The key measurements made with this configuration include in-channel tests such as output power and occupied bandwidth, and out-of-channel tests such as harmonics and intermodulation distortion.

2.5 Digital signal generator requirements

When choosing a CDMA signal generator there are several requirements to consider. Coverage of the frequency range of the amplifier is, of course, the first requirement.

When making in-channel tests, the key requirement for the signal generator is waveform quality. This provides a spectrally correct CDMA signal within the 1.23 MHz channel bandwidth.

When making out-of-channel tests, the key requirement for the signal generator is that it has excellent adjacent-channel-power performance. In order to meet the stringent spectral-regrowth specifications placed on CDMA power amplifiers, it is important that the signal generator is not contributing any adjacent-channel interference to the measurement.

To test the amplifier under real-world conditions, the signal generator must provide a realistic CDMA signal. The specification in IS-97 states that an appropriate signal for emulating real-world CDMA includes one pilot, sync, and paging channel and six traffic channels with specified power levels. Depending upon the data and specific traffic channels selected, this can provide a signal with a crest factor of up to 14 -15 dB.¹ A generator which allows selection of different Walsh-coded channels, power levels, and data is important for fully characterizing the base station amplifier.

The HP ESG-series digital signal generators offer an excellent source for CDMA base station amplifier testing. These sources provide pre-loaded waveforms which simplify CDMA signal generation. For example, the specified 9-channel waveform with pilot, paging, sync and 6 traffic channels is already pre-loaded into the generator. In addition, precise signal statistics, such as individual Walsh-coded channel-power levels, can be generated to optimize measurement accuracy.

1. See reference 1. for a detailed discussion on how the crest factor, or peak-to-average ratio, affects distortion measurements

Another CDMA signal generator available from HP is the HP Multi-Format Communications Signal Simulator (MCSS). This is a very versatile solution, offering multicarriers (both CW and digitally-modulated signals), as well as noise-power ratio (NPR) measurements for use in testing multicarrier amplifiers (MCPAs).

2.6 Signal analyzer requirements

As with the digital signal generator, the most important requirements for the signal analyzer are frequency range and performance. Accuracy, repeatability, and dynamic range are the key performance parameters.

The ability of the analyzer to measure the adjacent-channel power or spectral regrowth is determined by its dynamic-range performance. IS-95 CDMA system requirements, using a 30 kHz resolution bandwidth, are -45 dBc at ± 885 kHz offset and -60 dBc at ± 1.98 kHz offset. Base station amplifier specifications are typically better than this.

It can also be very important, even in R&D, that the measurements be fast and easy to make. This allows the R&D engineer to focus on his or her amplifier design rather than the test equipment and measurement details. Downloadable software programs provided for the analyzers can make complicated CDMA measurements much easier and do not require the user to write his or her own programs.

An analyzer with the flexibility to change parameters such as integration bandwidths, mask limits, or frequency offsets can allow for testing a variety of amplifier designs. Analyzers with sophisticated error and signal quality analysis capabilities make troubleshooting quick and easy.

HP spectrum analyzers that can be used to make in- and out-of-channel measurements include the HP 8590 E-series and HP 8560 E-series. The HP 8590 E-series spectrum analyzer has a measurement personality available specifically for CDMA, providing one-button measurements (HP 85725C). If higher performance is required, the HP 8560 E-series spectrum analyzer provides higher dynamic range, lower noise floor, and better accuracy than the HP 8590 E-series. These analyzers require manual (or control through external PC) power calculations and settings.

For the highest versatility in the R&D environment, the HP 89441A provides numerous error and signal-quality-analysis results for troubleshooting amplifier designs.

2.7 Power meter requirements

The requirements for the power meter and sensors are fairly straightforward. Frequency range that covers both cellular and PCS CDMA is the first concern.

For high-power amplifiers, it is also important that the power sensor has the appropriate power-measurement range for the amplifier's expected output power.

In terms of power accuracy, a power meter has the best performance of any other test equipment. It is also necessary for improving accuracy for some network-analysis measurements.

Using a dual-sensor power meter allows monitoring both the input and output power of the amplifier under test. This gives you the ability to make CDMA gain measurements (as opposed to CW gain measurements made with a network analyzer) by ratioing the input and output power.

Depending upon which sensor is used, the HP EPM 442A dual-channel power meter can measure from -70 dBm to $+44$ dBm at frequencies from 100 kHz to 110 GHz. The HP ECP E18A power sensor has a wide dynamic range (-70 dBm to $+20$ dBm) over the frequency range of 10 MHz to 18 GHz.

3. Measurements and test instruments

Now that you have read about the basic test-system architectures and the requirements for the various pieces of test equipment, the actual measurements made on CDMA base station amplifiers will be presented. In addition to describing the measurements, included is a brief description of some of the Hewlett-Packard test equipment that can be used.

3.1 Pulsed-RF and pulsed bias

This section covers testing techniques that use pulsed bias and pulsed RF to test unpackaged devices that lack sufficient heatsinking to be run continuously. Pulsed testing is common for on-wafer measurements of RF amplifiers.

Figure 8: Pulsed-RF network analysis

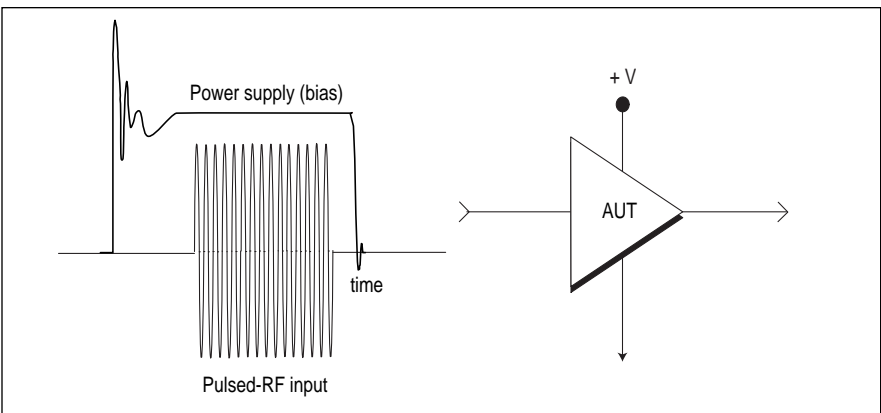

Pulsed-RF network analysis allows you to study the behavior of the power amplifier when stimulated with a burst of RF energy.

When testing high-power amplifiers that are not yet packaged, it is often necessary to apply the RF input just long enough to make the measurement, but not long enough to cause the temperature of the device to rise too much. Many of these amplifiers would burn-up if tested with a continuous RF input at the desired amplitude level, since adequate heatsinking is usually unavailable at the wafer or chip stage. Testing with low-power levels is often unacceptable since it may not accurately predict the results under large-signal operation. Using pulsed-RF stimulus allows measurements to be made with high input and output powers, which more closely simulates the actual operating environment of these high-power amplifiers.

Pulsed-RF testing is often further complicated by the additional need for a pulsed bias. Many unpackaged devices cannot be run with continuous RF input or bias current. For this situation, a high-speed low-inductance bias switch is used at the output of the power supply. A slightly wider pulse than that used to modulate the RF signal modulates the DC power supply. The bias is turned on a short time before the pulsed-RF signal appears, and is turned off shortly after the pulsed-RF signal disappears. The bias pulse needs to be applied early enough to allow overshoot and ringing of the supply to settle before pulsing the RF. Typically, a trade-off must be made between power-supply voltage, current, and duty cycle, because of the maximum power a pulsed-bias supply can deliver.

HP's solutions for pulsed-RF testing are the HP 85108L (45 MHz to 2.3 GHz) and HP 85108A (2 to 20 GHz) network analyzer systems. These systems can handle high CW power: up to 50 W for the HP 85108L and 20 W for the HP 85108A, and up to 100 W peak power.

Additionally, fully configured, customized systems are available for single-connection, multiple-measurement applications, which allow full characterization of the entire range of linear and non-linear amplifier behavior.

3.2 Load-pull analysis

Load-pull analysis can be used to optimize the design of a power amplifier. Under large-signal conditions the AUT output parameters change as a function of the drive level and load impedance. In order to measure these "large-signal S-parameters" versus drive level, the input power and load impedance is varied while the output parameters are measured.

Figure 9: Load-pull analysis

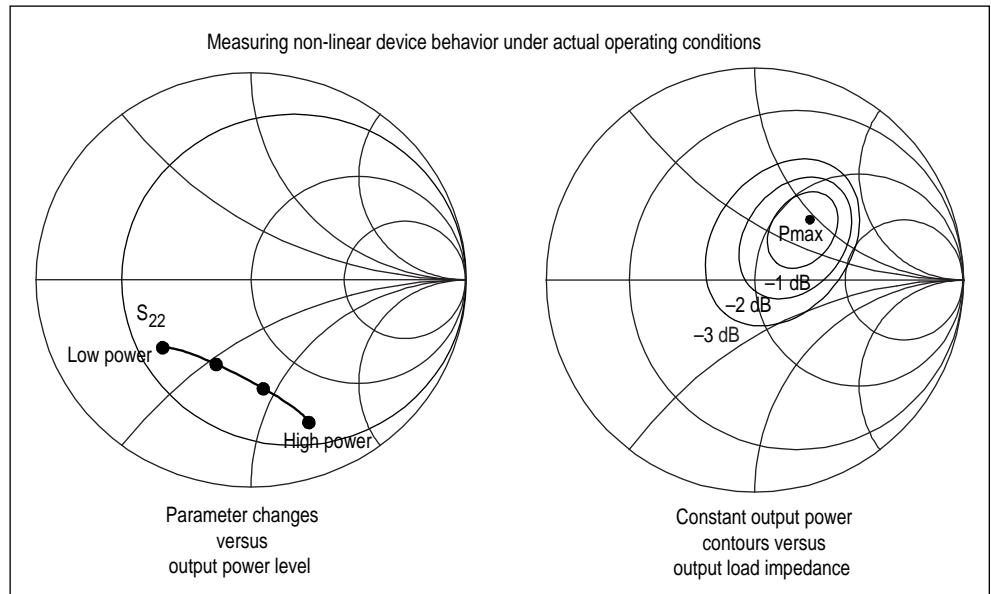

Power amplifiers are unique in that their input and output impedance can vary versus the input RF level and the output load impedance. Characterization of this very non-linear phenomenon is accomplished by load-pull techniques.

The fashion in which the output impedance shifts as a function of output power is unpredictable and renders small-signal S_{22} measurements useless for predicting large-signal operation. Therefore, a load-pull measurement is required at each power level and frequency of interest.

Load-pull analysis:

- 1) Measures amplifier output impedance for a given load condition.
- 2) Measures optimum load impedance for maximum power transfer at any input RF power level.
- 3) Measures non-linear as well as linear amplifier behavior.
- 4) Measures amplifiers under large-signal operating conditions.

The most common result of a load-pull measurement is a series of constant output-power contours (not always circular), plotted on a Smith chart which represent all possible output impedances. A load-pull measurement is required at each power level and frequency of interest, since the output contours are sensitive to these variables for most high-power amplifiers. The output-power contours shown are with a constant input power level and frequency.

With the many measurements to be made, it is important that a load-pull-measurement system be easily configured and provide fast measurements.

Hewlett-Packard Company and ATN Microwave, Inc. have teamed to develop several load-pull systems which are completely integrated and specified to support large- and small-signal characterization. Fully configured turn-key systems offer the ultimate in ease-of-use and performance.

3.3 Network analysis

Stimulus-response measurements which measure transmission and reflection parameters using a CW swept source are typically made using a network analyzer, and are therefore referred to as network-analysis measurements.

3.3.1 Transmission measurements

Figure 10: Network analysis transmission measurements

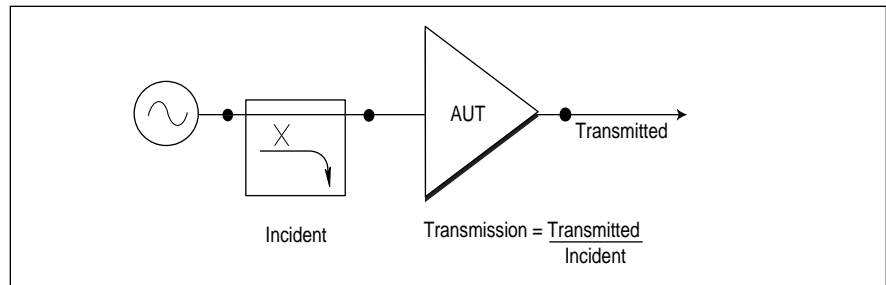

Transmission measurements are the ratio of the transmitted signal to the incident signal. The swept-frequency transmission measurements commonly made on CDMA power amplifiers include gain and phase, gain flatness, group delay, and isolation (reverse transmission). These measurements cover linear and non-linear behavior, and are scalar (magnitude only) and vector (magnitude and phase) quantities.

3.3.1.1 Gain and flatness

Figure 11: Gain and flatness measurements

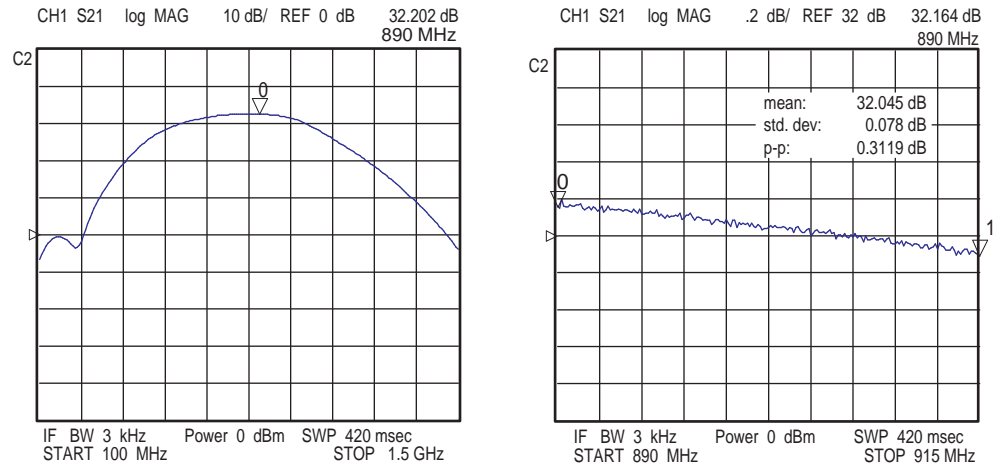

RF amplifier gain is defined as the ratio of the output power an amplifier delivers to a Z_o load, to the input power delivered from a Z_o source, where Z_o is the characteristic impedance of the system. Using S-parameter terminology, this is called S_{21} .

Gain can be calculated as the difference between the output and input power levels when they are expressed in logarithmic terms such as dB.

Amplifier gain is most commonly specified as a minimum value over a specified frequency range, assuming that input and output signals are in the amplifier's linear operating range. Since variations in the frequency response of the amplifier can cause signal distortion, gain flatness is often specified as how much the gain varies over the specified frequency range.

Shown in Figure 11 is the gain of an amplifier from 100 to 1500 MHz. The marker shows the gain at 890 MHz. This amplifier's gain and flatness are specified only from 890 to 915 MHz, as measured on the right. The marker-statistics function shows the mean, standard deviation, and peak-to-peak values of gain over the specified frequency range of the amplifier.

CW gain, as shown here, is an important amplifier test, particularly for alignment purposes. Another important gain measurement is CDMA gain. This requires using a digitally-modulated source and a broadband power sensor. Most CDMA base station amplifiers have a specification for CDMA gain.

3.3.1.2 Phase

Figure 12: Deviation from linear phase

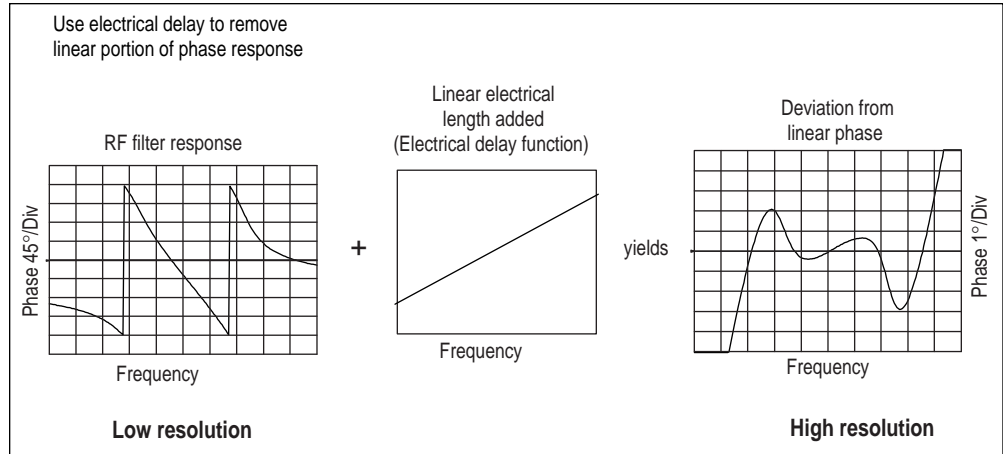

Gain and gain flatness are both magnitude-only measurements. Phase measurements, or more importantly, deviation from linear phase, must be made using a vector network analyzer. This measurement is equivalent to measuring insertion phase of a filter. The phase responses of amplifiers are usually better behaved than those for filters. Ideally, phase shift through the amplifier is a linear function of frequency to ensure distortionless transmission of signals. Another way of saying this is that the phase versus frequency trace is a straight line, with the slope proportional to the electrical length of the device. In actual practice, this is usually not the case, and a method for determining the deviation from linear phase is required.

The electrical-delay feature internal to the network analyzer can be used to effectively subtract electrical delay from the measured data, in order to flatten the displayed trace. This allows the vertical resolution to be increased, thereby providing a more accurate measurement of the deviation from the average straight-line phase measured through the amplifier. This deviation measurement provides insight to the phase non-linearities (phase distortion) of the amplifier, and can be specified as one of the amplifier's parameters.

Another way of expressing this phase distortion is by measuring or specifying the group delay of the amplifier.

Figure 13: Group delay calculation

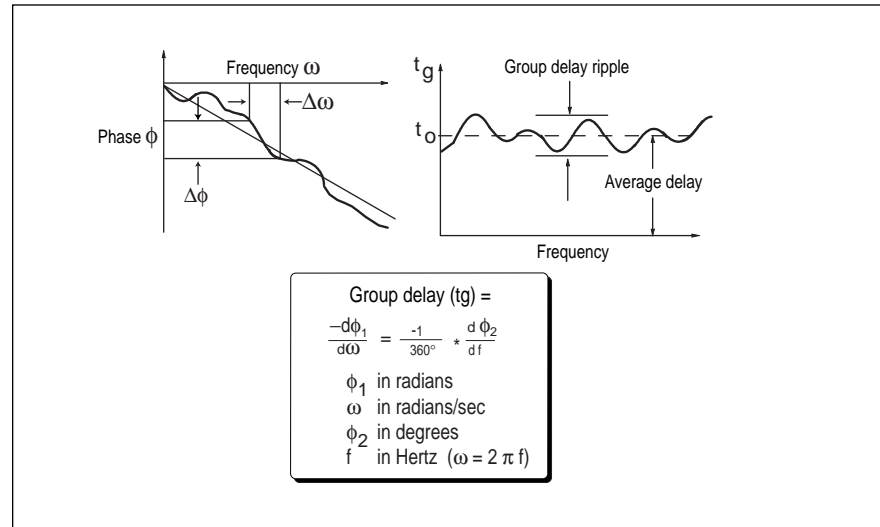

Group delay, like deviation from linear phase, is a measure of amplifier phase distortion. It is a common specification for communications amplifiers. Group delay is the actual transit time through an amplifier at a particular frequency, and is defined as the negative of the derivative of the phase response with respect to frequency. A perfectly linear phase response produces a flat group delay.

Vector network analyzers calculate group delay from the phase versus frequency information using a "phase slope" method. This method computes the slope of the phase trace between two closely spaced frequencies. The only limitation of this technique is that the frequency spacing between any two adjacent points must be kept small enough to guarantee that the phase difference between those points is less than 180 degrees. This condition ensures that accurate results will be displayed. The frequency spacing used in the calculation is the total frequency span divided by the number of trace points, and is also called the measurement aperture.

Changing the aperture, or frequency spacing, affects both the noise and resolution of the measurement. A wider aperture has lower noise but less resolution, whereas a narrower aperture provides more resolution but has higher noise. The important thing to remember is that for comparison of group delay data, or when specifying group delay, it is imperative to also know or specify the aperture used for the measurement.

Figure 14: Group delay responses

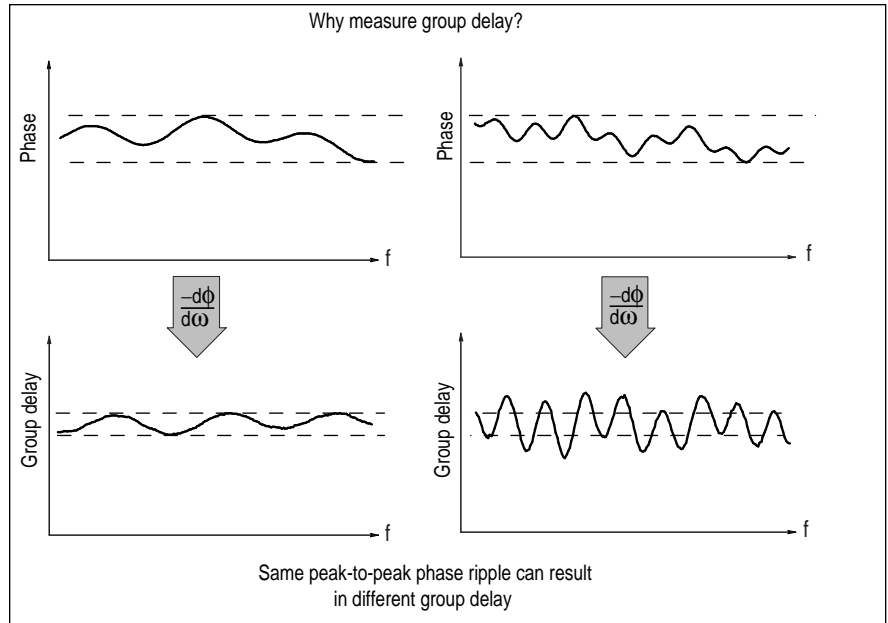

Specifying a maximum peak-to-peak value of phase ripple is not sufficient to completely characterize a device since the slope of the phase ripple is dependent on the number of ripples which occur per unit of frequency. Group delay takes this into account since it is the differentiated phase response. Group delay is often a more accurate indication of phase distortion.

The plots in Figure 14 show that the same value of peak-to-peak phase ripple can result in substantially different group-delay responses. The response on the right with the larger group-delay variation would cause more signal distortion.

3.3.1.4 Reverse isolation

Figure 15: Reverse isolation measurement

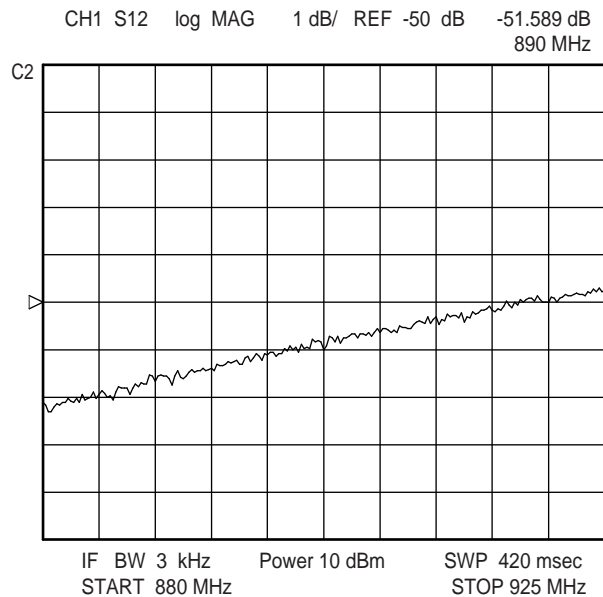

Reverse isolation is a measure of amplifier transmission from output to input. The measurement of reverse isolation is similar to that of forward gain, except the stimulus signal is applied to the output of the amplifier and the response is measured at the amplifier's input. The equivalent S-parameter is S_{12} .

When using a network analyzer with a transmission/reflection test set for measuring reverse isolation, the amplifier must be disconnected and physically turned around so that the stimulus from the source port is applied to the amplifier's output. If an S-parameter test set is used, the test set will switch the stimulus to the second port, eliminating the need to disconnect and reverse the amplifier.

There are several things that can be done to improve the accuracy of an isolation measurement. Since amplifiers generally exhibit loss in the reverse direction, there is no need for any attenuation that may have been used to protect the receiver during forward transmission measurements. Removing the attenuation will increase the dynamic range and hence the accuracy of the measurement, but a new response calibration should be done for maximum accuracy. The RF source power can also be increased to provide more dynamic range and accuracy. Note that with the attenuation removed and the RF source power increased, a forward sweep cannot be done. Reducing IF bandwidth or using averaging also improves measurement accuracy, at the expense of measurement speed.

3.3.2 Reflection measurements

Figure 16: Network analysis reflection measurements

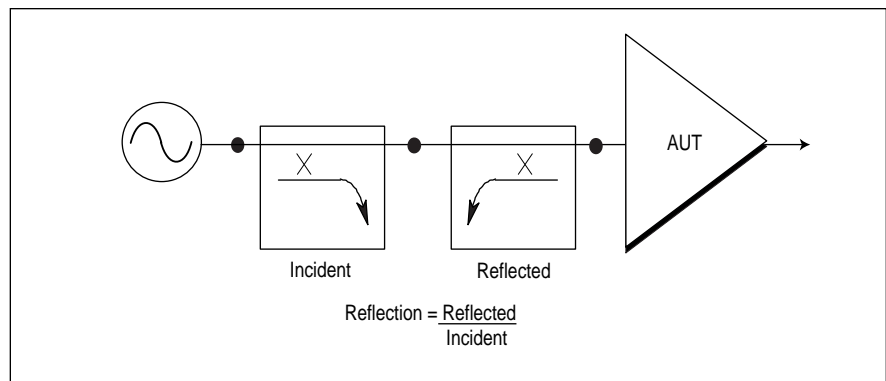

Reflection is the ratio of the reflected signal to the incident signal provided by the network analyzer's RF source. Typical reflection measurements include return loss, VSWR, and impedance, measured on both the input and output of the amplifier.

As with transmission measurements of amplifiers, you must pay attention to several important issues concerning the test instrumentation to ensure accurate reflection measurements.

When making reflection measurements, the main sources of error in the hardware are the directivity of the signal-separation components such as the input or output coupler, the source and load match, and the channel-to-channel tracking of the network analyzer. Just as for transmission measurements, proper calibration will greatly reduce the systematic effects of these parameters.

3.3.2.1 Return loss/SWR

Figure 17: Return loss measurement

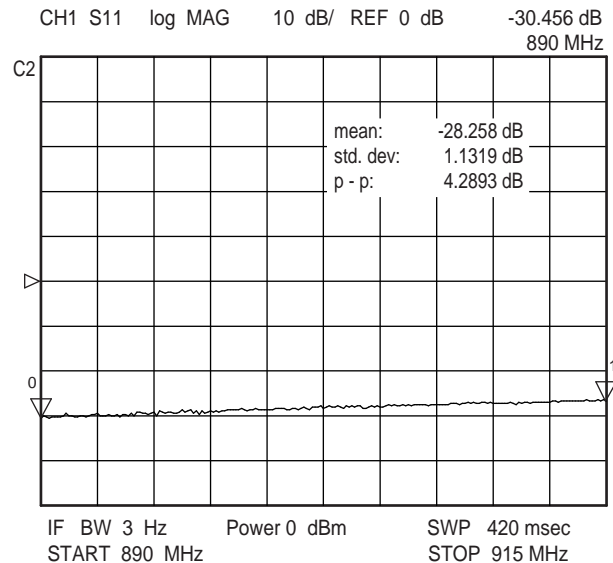

Reflection measurements can either be magnitude-only, or include both magnitude and phase. The two common magnitude-only specifications for amplifiers are return loss (in dB), or voltage-standing-wave ratio (VSWR, or SWR for short). If ρ is the linear reflection coefficient, then SWR is equal to $(1 + \rho)/(1 - \rho)$, and return loss is equal to $-20 \log |\rho|$ (a positive dB value). Return loss is also measured as $20 \log |S_{11}|$, which is a negative dB value (as shown in Figure 17). Physically, return loss is a measure of how far the reflected signal is below the incident signal.

The above plot shows the input-return loss of an amplifier. The measured return-loss value of -28 dB corresponds to a SWR measurement of 1.08 to 1. Modern network analyzers provide for display of both return loss and SWR.

To increase the signal-to-noise ratio of reflection measurements, the source power level can be increased above the level used for transmission measurements. Since we are not measuring at the output of the amplifier, it does not matter if the output power is high enough to cause some receiver compression. However, care should be taken to not exceed the safe input level of the network analyzer. Applying power above this level may cause damage to the input samplers or the internal transfer switch. Re-calibrating the instrument at the higher source power level is recommended.

3.3.2.2 Input impedance

Figure 18: Input impedance measurement

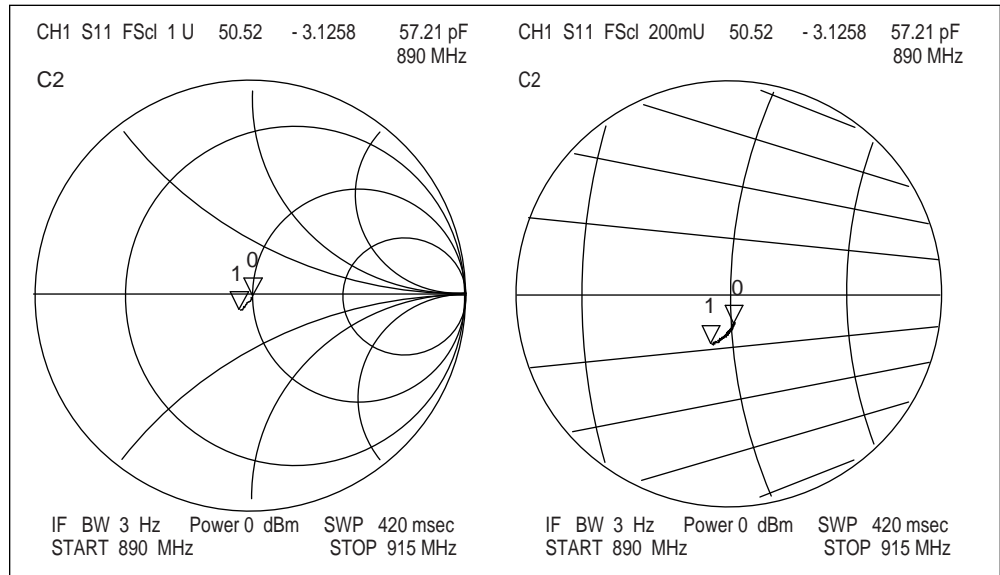

Reflection measurements can also determine the input impedance of a device. This parameter is usually expressed as S_{11} , and it is very important to know for proper impedance matching to maximize power transfer. Since we are now measuring a complex parameter, a vector network analyzer is required for this measurement. Modern network analyzers plot impedance in a Smith-chart format. Marker formats include direct readout of impedance and admittance (resistive and reactive, including equivalent inductance or capacitance), linear magnitude and phase, and log magnitude and phase.

Shown in Figure 18 is the S_{11} measurement of an amplifier with both full scale and expanded scale displays. The markers show the limits of the specified frequency range of the amplifier.

3.3.2.3 Output impedance

Figure 19: Output impedance measurement

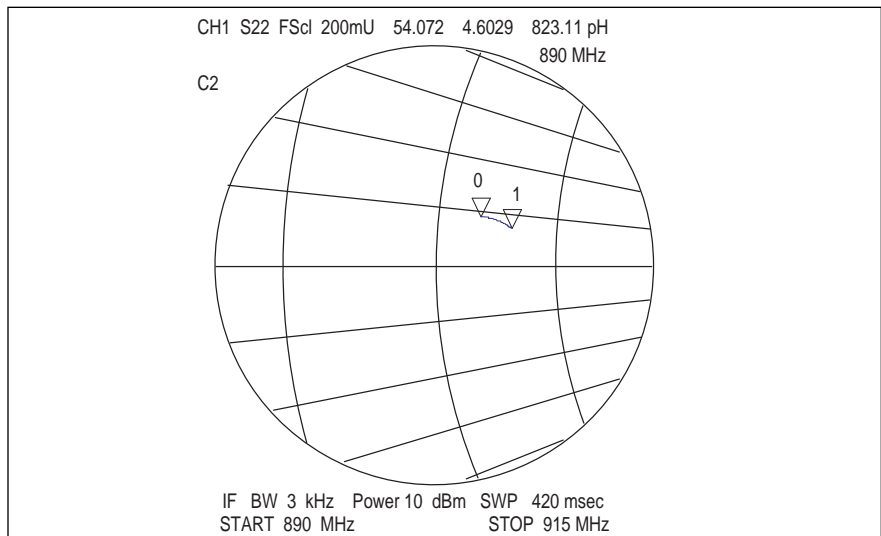

Just as S_{11} can be measured, output impedance or S_{22} can also be easily measured with an S-parameter network analyzer. As in the case with reverse-isolation measurements, the RF power level applied to the output of the amplifier can be increased to improve measurement accuracy. Additionally, any attenuation which may be in place for receiver protection can be removed since the reflection measurement is made in the reverse direction. Both of these changes require re-calibration of the instrument.

More importantly though, an S_{22} measurement of an amplifier is only valid as long as the amplifier is operating in its linear operating range. Since there is no RF applied to the amplifier input during an S_{22} measurement, the output is certainly in a linear range.

When an amplifier is not operating in its linear range, the small-signal S_{22} parameter is no longer representative of the amplifier's actual output impedance. Under these circumstances, it is necessary to measure the output impedance under these higher-power operating conditions. This type of testing has traditionally been done with load-pull techniques, as covered earlier.

3.4 In-channel measurements

Stimulus-response measurements that require a separate source and receiver are shown in Figure 7 on page 12. In-channel measurements such as channel output power and occupied bandwidth are presented first.

3.4.1 RF-channel output power

Measuring channel power in a digital-communications system is not as straightforward as it may seem. The standards for the different communications formats typically describe the method by which channel power should be measured. In CDMA, for example, it is specified to use a power-detection method. The implementation of this, however, is not specified. In fact, there are two ways to implement power detection.

One method is to use a voltage detector and convert to power using software. This software implementation is the most common method using traditional spectrum analyzers. The other method, which we will call the hardware implementation, can be done using either a hardware RMS power detector, or a voltage detector which then converts to power using digital hardware.

Although a power meter is a faster method, it is broadband and will therefore measure additional power outside of the channel bandwidth. A spectrum analyzer that converts to power using digital hardware is also a faster method, but has no other advantage over a traditional spectrum analyzer. For example, stability and accuracy are not improved as long as the software implementation corrects for any inherent errors that could cause degradation in these areas.

When making a power measurement on a CDMA signal, a spectrum analyzer using software-implemented power detection makes the measurement correctly with a high degree of stability and accuracy, as long as a few simple rules are followed:

Figure 20: Power detection using software implementation

- Sample detector for accurate noise detection
- Res BW << Channel Bandwidth
- Video BW > 10 x Res BW
- Use averaging to improve repeatability (not video averaging)

$$P = \frac{B_s}{B_n} * \frac{1}{N} * \sum_{i=1}^N P_i$$

B_n = noise equivalent bandwidth
 B_s = channel bandwidth
 P_i = power in one spectrum analyzer pixel
 N = number of pixels within channel limit

First, sample detection is required to accurately capture the noise voltage of the CDMA signal. Next, the resolution bandwidth should be set close to 1% of the emission bandwidth of the signal to achieve selectivity. Also, video bandwidth should be set wider than the resolution bandwidth to allow the noise voltage to vary throughout its full range of values. These detected noise voltages can then be converted to power, averaged and summed in a linear fashion to compute the true absolute power in the RF channel.

This integrated measurement can be done either by exporting the spectrum analyzer data to a PC and performing the calculation externally, or by using a downloadable software program for the analyzer, if available.

In order to improve repeatability of the measurement, averaging several measurements is necessary. This provides *true power averaging*. Again, this can either be done with an external PC or a downloadable software program for the analyzer.

Video averaging is not the same as averaging several measurements and should not be used. This will actually introduce errors in the measurement. Video averaging or video filtering averages the *logarithmic* values of the trace elements. This averaging can cause a skewed result. For noise-like signals such as CDMA, the error is -2.51 dB when the VBW << RBW or the number of video averages is high. Note that for CW signals the error is 0 dB.

Figure 21: RF-channel output power measurement

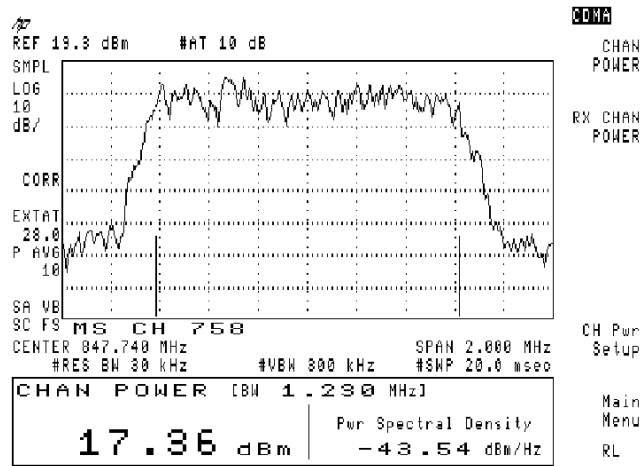

The HP 85725C CDMA personality software for the HP 8590 E-series spectrum analyzers automatically sets the instrument controls as described previously and performs the necessary calculations. The results are reported in total power and in power-spectral density in a 1 Hertz bandwidth.

A key advantage of the HP 85725C is its ability to average several measurements, or perform *true power averaging*. CDMA signals are very noise-like and therefore require averaging in order to improve accuracy and repeatability.

This measurement can also be done using the built-in channel-power function on the HP 8590 E-series or HP 8560 E-series spectrum analyzers; however, these do not provide true power averaging, and would therefore require exporting the data to a PC for improved repeatability.

3.4.2 Occupied bandwidth

Figure 22: Occupied bandwidth measurement

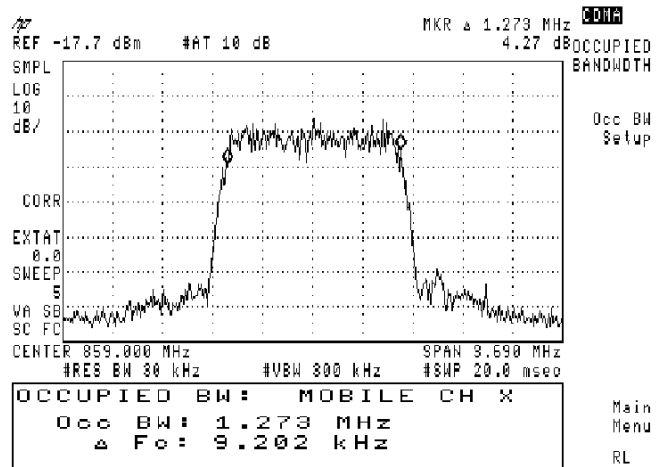

Occupied bandwidth is a measure of the bandwidth containing 99% of the total integrated power of the displayed spectrum.

The plot in Figure 22 shows the occupied bandwidth result, again using the HP 85725C measurement personality. The percentage value can be changed via the front panel, if desired.

3.5 Out-of-channel measurements

The last group of measurements covered are those that characterize the out-of-channel performance of the amplifier. Linearity requirements are specified by several figures of merit, including harmonics, adjacent-channel power, and spectral regrowth. These measurements tell us how much distortion is caused by the non-linearities in the amplifier.

Amplifier linearity is critical to the performance of CDMA systems. In these systems, the transmitted power is very dynamic and can experience input power variations on the order of 20 dB. This drives the need for the amplifiers to operate linearly in this range. Understanding the non-linear performance is important since excessive distortion can cause interference in adjacent channels or other frequency bands.

Traditionally, characterizing the linearity performance of a high-power amplifier required a two-tone intermodulation distortion (IMD) measurement, and was sufficient for analog FM systems such as AMPS cellular. While this is well understood and uses more common test equipment, tests such as adjacent-channel power and spectral regrowth are becoming more accepted for measuring linearity of power amplifiers used in digital modulation systems.

3.5.1 Harmonic distortion

Figure 23: Harmonic distortion caused by non-linearities in the amplifier

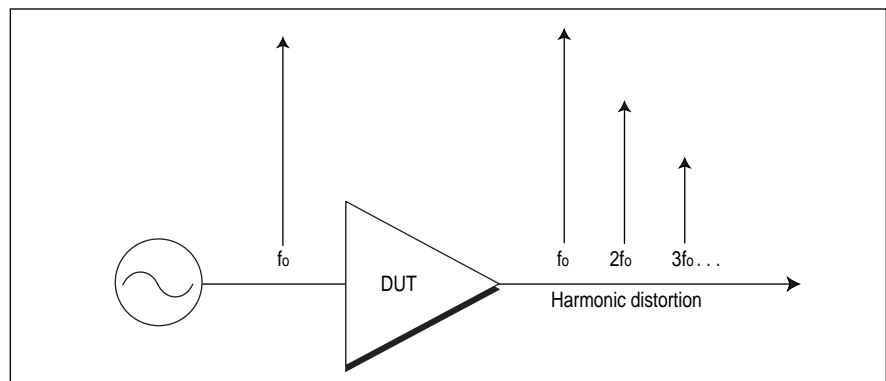

One way in which non-linear performance is specified for an amplifier is harmonic distortion. This is a measure of signals present at the output of the amplifier that were not present at the input. (This is one definition of non-linear behavior). A harmonic distortion measurement uses either a single sinusoid as a stimulus, or a CDMA signal.

As shown in Figure 23, non-linearities in the amplifier will cause harmonics of the input signal to appear at the output along with the fundamental. These harmonics are integer multiples of the input (fundamental) frequency, and are usually specified in terms of dB below the fundamental signal (or "carrier") for a given input level, commonly expressed as dBc.

In CDMA, the system specification for total spurious emissions outside the allocated system band (including harmonics), measured in a 30 kHz bandwidth, should not exceed 60 dB below the mean output power in the channel bandwidth, or -13 dBm whichever is smaller.

3.5.2 Adjacent channel power ratio

Figure 24: Example ACPR specification

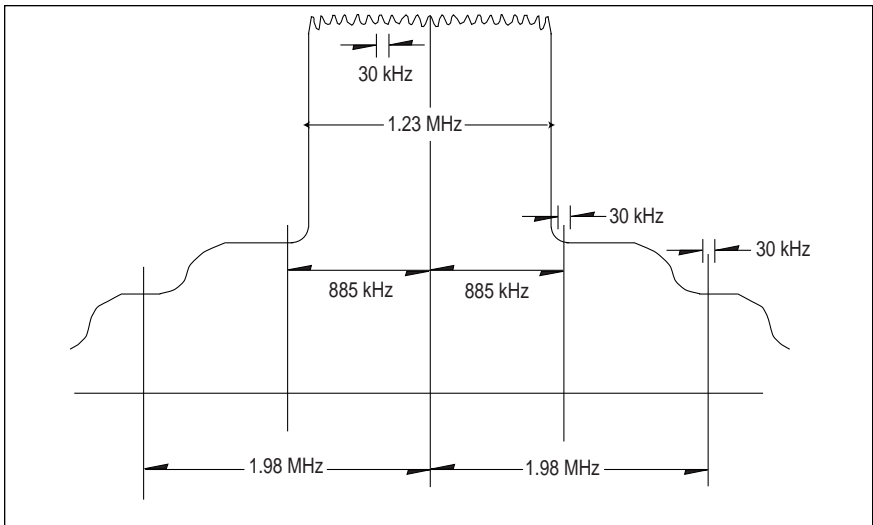

Another result of non-linear behavior in amplifiers is intermodulation distortion. Traditional intermodulation testing uses two tones. This method, however, does not relate well quantitatively to the performance in the final application for the complex base station amplifiers used in CDMA systems.

A better test for measuring the intermodulation distortion caused by a CDMA base station amplifier is adjacent-channel-power ratio (ACPR) or spectral regrowth. Both ACPR and spectral regrowth measure the same phenomena, but use different methods.

The specification for ACPR requires comparing the power in the RF channel to the power at several offsets. This can be done either as a power ratio or a power density.

The power-ratio method compares the power in the specified adjacent-channel bandwidth (for example 30 kHz) to the total power of the carrier across the entire carrier bandwidth (1.23 MHz).

The power density method compares the power density at the offset frequency, in a 30-kHz bandwidth, to the power within an average bandwidth of the same (30-kHz) width in the carrier-channel bandwidth. This is the Qualcomm Inc. recommended method and can be calculated by normalizing the 1.23-MHz channel-power result to a 30-kHz bandwidth (subtract $10\log[1.23 \text{ MHz}/30 \text{ kHz}] = -16.13 \text{ dB}$ from the result).

This test requires stimulating the amplifier with a CDMA signal. The measurement is then typically made on a spectrum analyzer.

Figure 25: Two methods for measuring power at the offsets

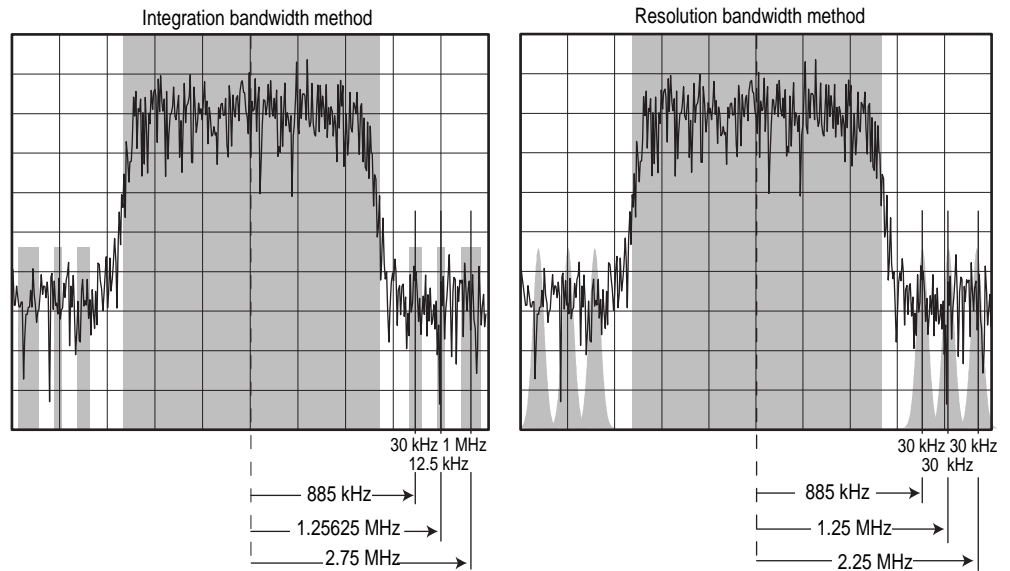

In addition to comparing the power in the RF channel to the power at several offsets as a power density, Qualcomm also recommends that the power at the offsets be measured using an integration bandwidth (IBW) method. An alternative to this, defined by Hewlett-Packard Co., is to use the resolution bandwidth (RBW) method. This is a faster method than the IBW method.

The integration bandwidth method measures the RF channel power across the 1.23-MHz bandwidth using the power algorithm described earlier for RF-output power (Figure 20 on page 27). The power at the offsets is calculated using this same algorithm, but with different integration bandwidths for the different offsets. The user can change the settings of these integration bandwidths. The plot on the left in Figure 25 shows integration bandwidths of 30 kHz, 12.5 kHz, and 1 MHz for the $\pm 885 \text{ kHz}$, $\pm 1.25625 \text{ MHz}$, and $\pm 2.75 \text{ MHz}$ offsets, respectively.

The resolution bandwidth method also measures the RF channel power across the 1.23-MHz bandwidth using the power algorithm described earlier for RF-output power. For the power at the offsets, however, this method uses a specified resolution bandwidth (for example 30 kHz as shown in Figure 25) and zero span. In the case of the RBW method the bandwidth used can also be changed by the user and is the same for all offsets.

After the main-channel power and power at the offsets are obtained, the ACPR is calculated and displayed as either a power ratio or a power density.

Figure 26: Adjacent-channel-power-ratio measurement

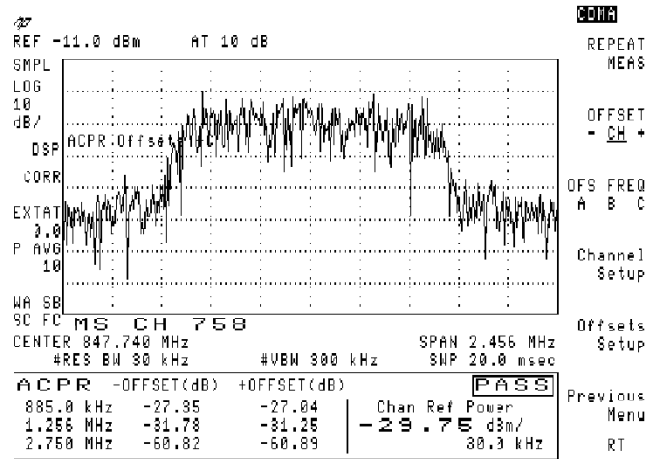

The ACPR measurement shown in Figure 26 was made with the HP 8590 E-series spectrum analyzer and HP 85725C CDMA measurement personality. In this example, the IBW method was used.

The plot also shows the power density results. This is the ratio of power in the main channel normalized to 30 kHz and power at the offsets normalized to 30 kHz. The result is given in dB. A different normalizing bandwidth can also be selected.

It is possible to toggle between the power density and power ratio results, if desired. The power ratio result is the ratio of the total power in the main channel (dBm/1.23 MHz) to the power at the offsets. This result will be given in dBc.

As with channel power, the capability to do true power averaging improves the repeatability of the measurement.

3.5.3 Spectral regrowth

Figure 27: Intermodulation distortion causes spectral regrowth

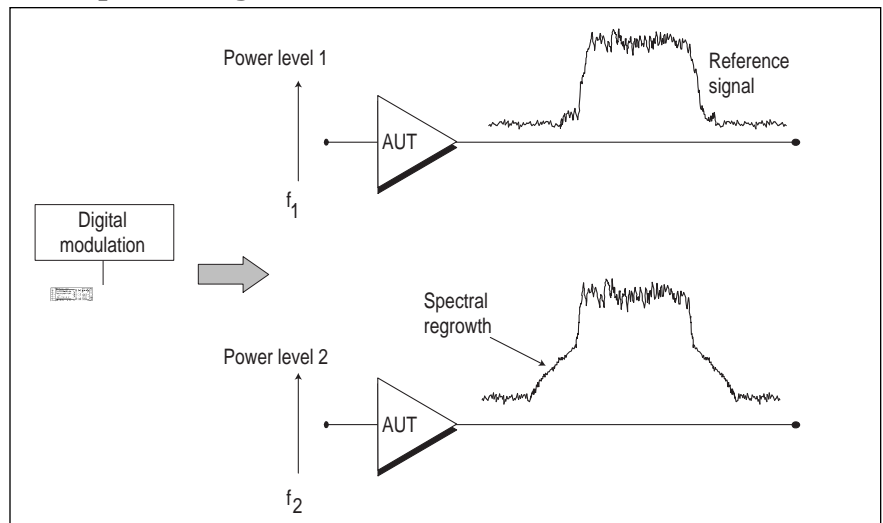

A different way of viewing the same distortion phenomenon is called spectral regrowth. As you have seen, the distortion products of the modulated carrier cause additional spectral components at the sides of the desired spectrum. While ACPR measures the actual power in a given bandwidth at various offsets, the spectral-regrowth measurement is the net spectral distortion that results as the output power of the amplifier is increased. This requires comparison to a test mask, sometimes called mask-performance measurements.

The measurement procedure is to make an initial measurement with the amplifier at reduced output power (typically 10 to 20 dB below maximum), and store it as the reference trace. The output power of the amplifier is then increased to measure the magnitude of spectral regrowth. The maximum spectral regrowth value is computed and displayed.

Measuring the spectral regrowth by comparing it to a reference trace is difficult to do manually. A better way is to use a software program that will automatically subtract the two traces.

Figure 28: Spectral-regrowth measurement

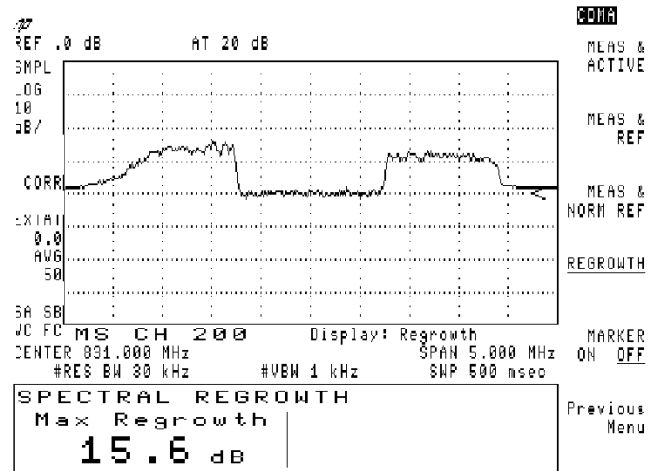

One way to view spectral regrowth is shown in Figure 28 using the HP 8590 E-series spectrum analyzer with the HP 85725C measurement personality.

The user can choose among various display modes for comparing measurement and reference spectrums. The display shown represents the measured average trace minus the stored reference trace normalized to the measured carrier power. This display allows the user to quickly and easily visualize the amount of spectral regrowth created by the amplifier. The maximum difference value is reported on the screen.

The user can also view the measured average trace along with either the active sweep trace, the stored reference trace, or the stored reference trace normalized to the measured carrier power.

4. Summary

Figure 29: Recommended test instruments for CDMA base station amplifier measurements

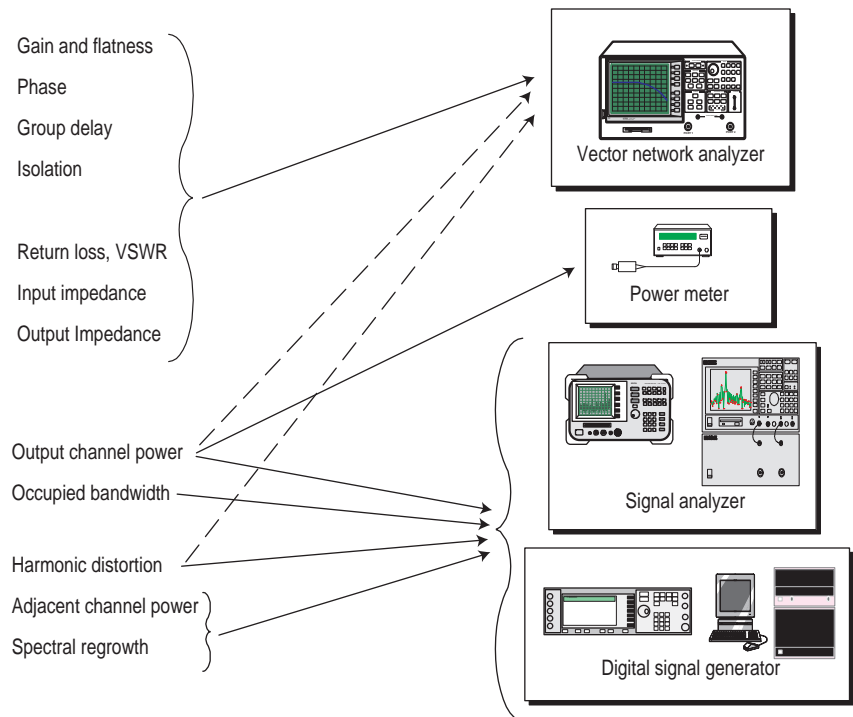

Amplifiers place significant demands on measurement instrumentation for accuracy, speed and versatility. This application note has covered all of the measurements shown above with the objective of sharing HP's experiences with you and demonstrating techniques and methods for fast and accurate measurements.

There are several test instruments required to effectively characterize all aspects of linear and non-linear amplifier performance. The majority of tests can be done with a vector network analyzer. Additionally, a digital signal generator and spectrum analyzer are required to accurately measure the distortion performance of an amplifier. A vector signal analyzer can aid troubleshooting activities with its modulation quality analysis. Power meters are also very useful instruments for amplifier measurements.

Shown in Figure 29 are the recommended solutions for each of the measurements covered in this tutorial. Alternatives are shown with dotted lines, and may provide sufficiently accurate results for your amplifier-test needs. Section 2 described the test systems requirements and how to maintain measurement accuracy.

In conclusion, you have read about several important measurements that are made on a CDMA base station amplifier. While not a complete or exhaustive list, these represent some of the more common, yet challenging, measurements.

Measurements particularly for design verification include:

- 1) Pulsed bias and pulsed-RF techniques which, when combined together, create an environment that is free from the adverse heating effects that plague power amplifiers.
- 2) Load-pull techniques to optimize a power amplifier design for maximum power transfer.

Also for design verification and in a manufacturing environment, the following tests are important:

- 3) Network-analysis measurements which tell us a lot about an amplifier's power efficiency and network characteristics. Several network analyzers from HP are available depending on your needs.
- 4) In- and out-of-channel measurements for characterizing an amplifier's output power and distortion performance. The ESG-D series signal generators provide an excellent CDMA stimulus. Multi-tone-testing capability is provided by the Multi-Format Communications Signal Simulator (MCSS). Measuring parameters such as output power, occupied bandwidth and distortion is easily accomplished with the HP 8590 E-series spectrum analyzer with HP 85725C CDMA measurement personality. The HP 8560 E-series spectrum analyzer provides higher performance, while the HP 89441A vector signal analyzer provides more sophisticated signal analysis and troubleshooting capability.

5. References

1. Nick Kuhn, Bob Metreci, and Pete Thysell, "Proper Stimulus Ensures Accurate Tests of ACP for the CDMA Forward Link", article reprint (HP 5966-4786E).
2. Darin Phelps, "Measurement Solutions for Testing Base Station Amplifiers", 1996 Device Test Seminar.
3. Hewlett-Packard Company, Using a Network Analyzer to Characterize High-power Components, Application Note 1287-6 (HP 5966-3319E)
4. Hewlett-Packard Company, Digital Modulation in Communications Systems - An Introduction, Application Note 1298 (HP 5965-7160E)
5. Hewlett-Packard Company, Spectrum Analysis, Application Note 150 (HP 5952-0292)
6. Hewlett-Packard Company, Understanding the Fundamental Principles of Vector Network Analysis, Application Note 1287-1 (HP 5965-7707E)
7. Hewlett-Packard Company, Exploring the Architectures of Network Analyzers, Application Note 1287-2 (HP 5965-7708E)
8. Hewlett-Packard Company, Applying Error Correction to Network Analyzer Measurements, Application Note 1287-3 (HP 5965-7709E)
9. Hewlett-Packard Company, Network Analyzer Measurements: Filter and Amplifier Examples, Application Note 1287-4 (HP 5965-7710E)

For more information about Hewlett-Packard test and measurement products, applications, services, and for a current sales office listing, visit our web site, <http://www.hp.com/go/tmdir>. You can also contact one of the following centers and ask for a test and measurement sales representative.

United States:

Hewlett-Packard Company
Test and Measurement Call Center
P.O. Box 4026
Englewood, CO 80155-4026
1 800 452 4844

Canada:

Hewlett-Packard Canada Ltd.
5150 Spectrum Way
Mississauga, Ontario L4W 5G1
(905) 206 4725

Europe:

Hewlett-Packard
European Marketing Centre
P.O. Box 999
1180 AZ Amstelveen
The Netherlands
(31 20) 547 9900

Japan:

Hewlett-Packard Japan Ltd.
Measurement Assistance Center
9-1, Takakura-Cho, Hachioji-Shi,
Tokyo 192, Japan
Tel: (81) 426 56 7832
Fax: (81) 426 56 7840

Latin America:

Hewlett-Packard
Latin American Region Headquarters
5200 Blue Lagoon Drive, 9th Floor
Miami, Florida 33126, U.S.A.
Tel: (305) 267-4245
(305) 267-4220
Fax: (305) 267-4288

Australia/New Zealand:

Hewlett-Packard Australia Ltd.
31-41 Joseph Street
Blackburn, Victoria 3130, Australia
1 800 629 485

Asia Pacific:

Hewlett-Packard Asia Pacific Ltd.
17-21/F Shell Tower, Times Square,
1 Matheson Street, Causeway Bay,
Hong Kong
Tel: (852) 2599 7777
Fax: (852) 2506 9285

**Data Subject to Change
Copyright © 1998
Hewlett-Packard Company
Printed in U.S.A. 5/98
5967-5486E**